

Accuphase

MONOPHONIC POWER AMPLIFIER

M-8000

- Ultra-powerful output stage with 22 parallel push-pull transistors remains linear down to extremely low 1-ohm load impedance
- MCS configuration in input stage
- Stabilized power supply in driver stage
- Current feedback circuit topology assures great sound and stable operation
- Bridged use of two units possible for four times the output power
- Massive Super Ring toroidal transformer rated for 3 kVA max.





A monophonic power amplifier with impressive muscle: 2000 watts into 1 ohm – MCS topology for input stage assures high S/N ratio. 22 wide-band high power transistors in parallel push-pull configuration. Power supply with massive 3 kVA toroidal power transformer realizes constant voltage speaker drive and delivers linear power down to impedances as low as one ohm. Teflon PCBs with low dielectric constant and minimum loss.

When developing the M-8000, Accuphase took a fresh look at the entire concept of the power amplifier. As a result, the M-8000 was designed to realize the ideal of constant voltage drive, which is best implemented in a monophonic configuration. In order to bring out the full performance potential of any loudspeaker, unaffected by the often drastic fluctuations in speaker impedance, the amplifier must have very low output impedance (Note 1), and it must be able to supply a constant drive voltage (Note 2).

In the M-8000, a complement of 22 output transistors with a collector dissipation (P_c) of 150 watts each is used in the output stage. Connected in parallel, these devices have a combined collector dissipation of 6,600 watts. At the extremely low load impedance of 1 ohm, the amplifier is rated to deliver an amazing 2,000 watts. Constant voltage drive enables linear progression of output vs. load impedance. This performance is sustained by a massive Super Ring toroidal transformer housed in a diecast enclosure with directly mounted heat sinks, and by large filtering capacitors. The transformer is rated for 1,5 kVA, max. 3,0 kVA, and there are two capacitors of 40,000 μ F each. This assures more than ample reserves and allows the M-8000 to meet even the most demanding and rapidly fluctuating power requirements. Use of two units in bridged configuration is also possible, resulting in a mono amplifier with even higher capabilities.

The important input stage also has been given due attention. Another Accuphase innovation called MCS (Multiple Circuit Summing) helps to minimize noise. The predriver stage features a DC stabilized power supply. This results in drastically improved S/N ratio, minimum distortion, and superb performance in all other aspects. Stable output is achieved regardless of fluctuations on the AC side. Current feedback topology makes it possible to combine stable operation with impeccable frequency response. The circuit boards of the M-8000 possess a Teflon base with low dielectric constant and minimum loss. Balanced inputs help to shut out external noise. The copper foil side of PCBs and all input and output terminals as well as all major signal carrying points are gold plated. The overall result of these measures is musical purity that leaves nothing to be desired.

* Teflon is a registered trademark of DuPont USA.

Note 1: Low amplifier output impedance

When forming the load of a power amplifier a loudspeaker generates a counterelectromotive force that can flow back into the amplifier via the NF loop. This phenomenon is influenced by fluctuations in speaker impedance, and interferes with the drive performance of the output circuitry. The internal impedance of a power amplifier should therefore be made as low as possible by using output devices with high current capability.

Note 2: Constant drive voltage principle

Even when the impedance of a load fluctuates drastically, the ideal power amplifier should deliver a constant voltage signal to the load. When the supplied voltage remains constant for any impedance, output power will be inversely proportional to the impedance of the load. A conventional amplifier can be easily made to operate in this way down to a load impedance of about 4 ohms. However, at 2 ohms and below, much more substantial output reserves are needed. This can only be achieved by a thorough redesign of all basic amplifier aspects.

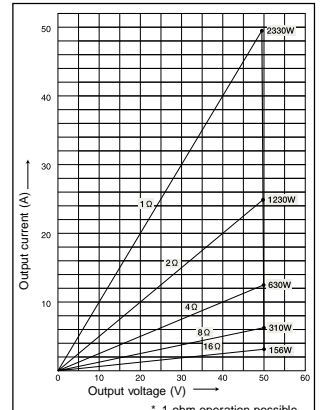
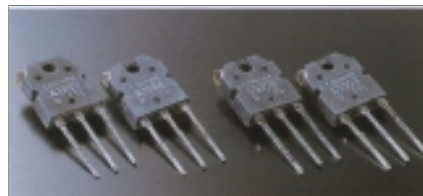

Fig. 2 Output power vs. load impedance
(output voltage/output current: actual measurements)

Ultra-powerful output stage with 22 parallel push-pull transistors delivers 2,000 watts into 1 ohm, 1,000 watts into 2 ohms, 500 watts into 4 ohms and 250 watts into 8 ohms

The M-8000 uses a complement of 22 high-power transistors with a collector dissipation (P_c) of 150 watts and a collector current of 15 amperes each.



These devices are excellent in every regard, including frequency response, current amplification linearity, and switching characteristics. The 22 devices are connected in a parallel push-pull configuration and mounted to immense heat sinks

made of diecast aluminum. This assures efficient dissipation of thermal energy and provides plenty of performance margin. As a result, the power amplifier is capable of delivering enormous output power in a linear progression towards lower load impedances: 2,000 watts into 1 ohm, 1,000 watts into 2 ohms, 500 watts into 4 ohms and 250 watts into 8 ohms. The M-8000 also is able to drive reactive loads with ease.

Figure 2 is a graph plotting the output voltage versus current characteristics. Even when the load changes, the output voltage remains almost constant, showing linear current progression. Actual measurement of clipping power at the extremely low load impedance of 1 ohm yields 2,330 watts. At 2 ohms, the figure is 1,230 watts, at 4 ohms 630 watts, and at 8 ohms 310 watts. This demonstrates the impressive performance reserves of this amplifier.

MCS topology in input stage drastically improves S/N ratio

The input stage features Accuphase's original MCS (Multiple Circuit Summing) design. Three separate unit amplifiers for the input signal are connected in parallel, which minimizes noise and distortion and greatly improves other performance parameters as well. This manifests itself in further improved sound quality.

Stabilized power supply in driver stage assures outstanding operation stability

The MCS circuitry and predriver stage employ a DC stabilized power supply. When the power stage amplifies a signal to large amplitudes, this could cause noise in the input stage via the power supply. This is prevented by fixing the voltage of the predriver stage, to improve the quality of the power supply for the low-level amplification stages. Outstanding S/N ratio and stable operation unaffected by ambient temperature and by AC line fluctuations is guaranteed at all times.

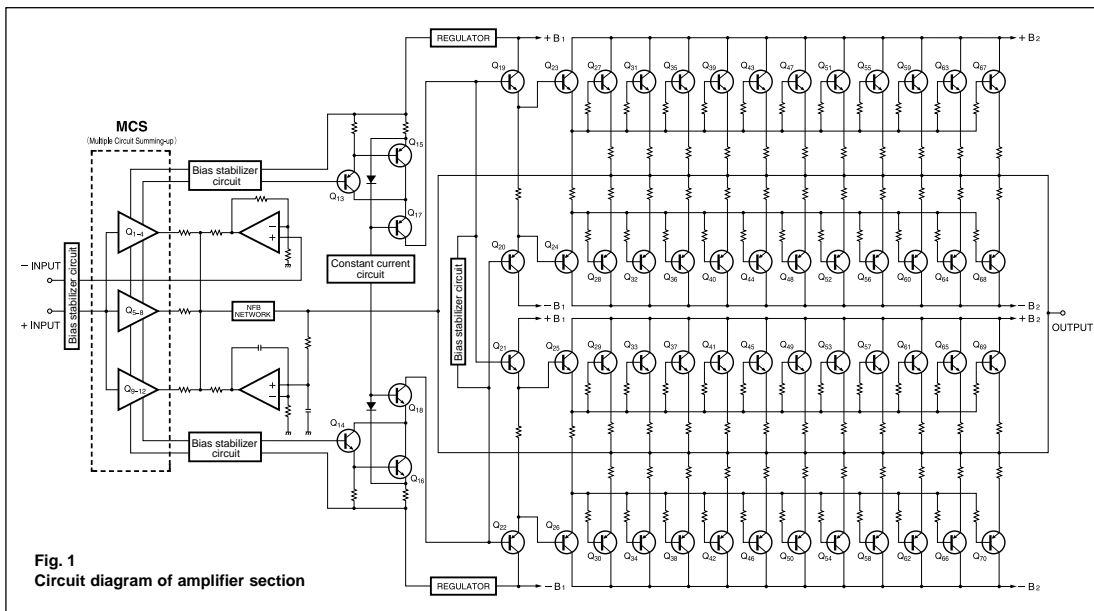



Current feedback circuit topology prevents phase shifts in high frequency range

The M-8000 employs the original Accuphase current feedback principle. Figure 3 shows the operating principle of this circuit. At the sensing point of the feedback loop, the impedance is kept low and current detection is performed. An impedance-

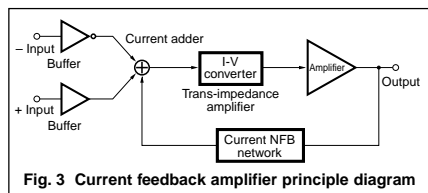

Fig. 3 Current feedback amplifier principle diagram

converting amplifier then turns the current into a voltage to be used as the feedback signal. Since the impedance at the current feedback point (current adder in Figure 3) is very low, there is almost no phase compensation can be kept to a minimum, resulting in excellent transient response and superb sonic transparency. Figure 4 shows frequency response for

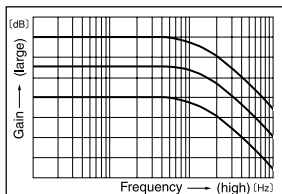

Fig. 4 Frequency response with current feedback (Response remains uniform even when gain changes)

different gain settings of the current feedback amplifier. The graphs demonstrate that response remains uniform over a wide range.

Use of two M-8000 in bridged configuration possible, resulting in a mono amplifier with four times the power

Bridged operation means that two amplifiers are driven by the same signal voltage but with opposite phase. The speaker load is then connected between the positive output terminals of the amplifiers. When used in a bridged configuration, two M-8000 units form a single mono amplifier with awesome power capabilities: 4,000 watts into 2 ohms, 2,000 watts into 4 ohms, or 1,000 watts into 8 ohms.

■ Power amplifier assembly with MCS circuit, current feedback amplifier circuitry, and output stage with 22 parallel push-pull transistors mounted directly to two large aluminum die-cast heat sinks

Printed circuit boards made from Teflon with low dielectric constant and low loss

The printed circuit boards for the signal-carrying circuits are made of Teflon, a glass fluorocarbon resin material. Teflon has extremely low specific inductive capacity which is desirable for fast signal transmission and a low dielectric dissipation factor which results in minimal transmission losses. High-frequency characteristics and heat resistance are also excellent. For further improved sound quality, the copper foil side is gold plated.

Robust power supply with "Super Ring" toroidal transformer and high filtering capacity

The M-8000 features a massive toroidal power transformer with a maximum rating of 3 kVA. The transformer is housed in a non-resonant aluminum case filled with a material that transmits heat and absorbs vibrations. This completely prevents any adverse influences on other circuit parts. A toroidal transformer uses heavy-gauge copper wiring on a doughnut-shaped core. This results in low impedance and high efficiency, while allowing compact dimensions. Two ultra-large aluminum electrolytic capacitors rated for 40,000 μ F each serve to smooth out the pulsating direct current from the rectifier, providing more than ample filtering capacity.

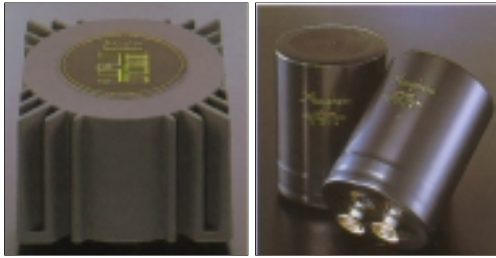

- **Balanced connection blocks induced noise**
- **PCB copper foil and all major signal path components are gold-plated**
- **Phase selector**
- **Extra-large speaker terminals**



Phase selector



Unbalanced and balanced inputs
(*2" indicates output connector for bridged connection)

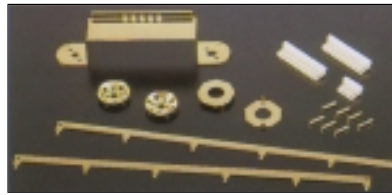

Gold-plated circuit components



Speaker terminals

Front panel

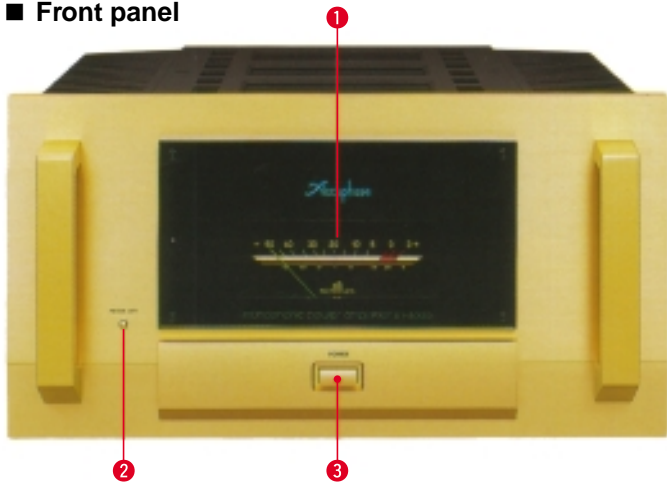

Rear panel

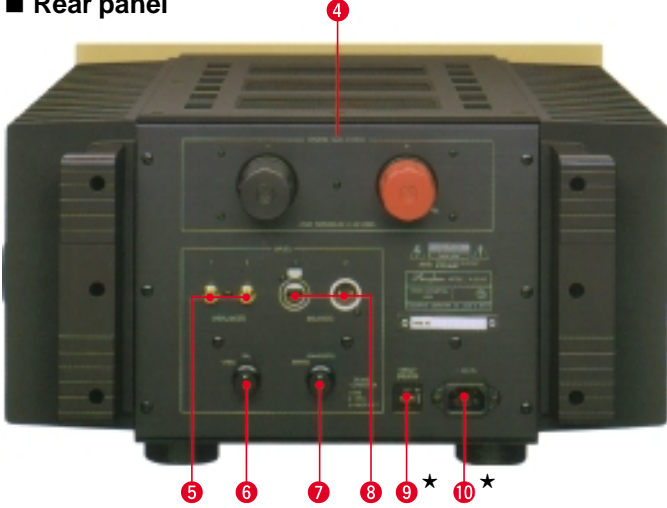

- | | |
|--|---|
| <ul style="list-style-type: none"> ① Peak Power Meter
(Output indication in dB and %) ② Meter Display ON/OFF Switch ③ Power Switch ④ Speaker Terminals ⑤ Unbalanced Input Jacks ⑥ Input Selector
UNBALANCED BALANCED | <ul style="list-style-type: none"> ⑦ Phase Selector
INVERTED NON-INVERTED ⑧ Balanced Input Connectors <ul style="list-style-type: none"> ① Ground ② Inverted (-) ③ Non-inverted (+) ⑨ AC Circuit Breaker* ⑩ AC Inlet* |
|--|---|

Remarks

- ★ This product is available in versions for 120/230 V AC. Make sure that the voltage shown on the rear panel matches the AC line voltage in your area.
- ★ The shape of the AC inlet and plug of the supplied power cord, and the circuit breaker current rating depend on the voltage rating and destination country.

■ Supplied accessories: • AC power cord

Parallel connection of output devices

Semiconductor devices for high-frequency applications often use the multi-chip principle where many small transistors or FETs are internally connected in parallel. This reduces internal noise and the internal impedance of the device. It also results in a larger surface area of the chip, allowing the heat to disperse more easily. This in turn contributes to operation stability. The M-8000 is based on a similar principle. By using multiple devices connected in parallel, current load is distributed. Signal attacks and transients which require a high amount of current to be available almost immediately can be handled with ease. But parallel connection in an Accuphase amplifier means more than simply stringing together a number of devices. Various sophisticated techniques are used to accommodate temperature characteristics and to optimize the current flow pattern. As a result, distortion at low current levels is improved, and signal-to-noise ratio is outstanding, assuring impressive dynamic range and sonic transparency. Ample current capability makes it possible for the amplifier to drive even extremely low loads with ease.

GUARANTEED SPECIFICATIONS

[Guaranteed specifications are measured according to EIA standard RS-490.]

- **Continuous Average Output Power** (20 - 20,000 Hz)
 - 2,000 watts into 1 ohm (★)
 - 1,000 watts into 2 ohms
 - 500 watts into 4 ohms
 - 250 watts into 8 ohms

Note: The rating marked (★) is for music signals only.
- **Total Harmonic Distortion** 0.05% with 2-ohm load
0.03% with 4 to 16-ohm load
- **Intermodulation Distortion** 0.003%
- **Frequency Response** At rated continuous average output: 20 - 20,000 Hz +0 -0.2 dB
At 1 watt output: 0.5 - 160,000 Hz +0 -3.0 dB
- **Gain:** 28.0 dB
- **Output Load impedance:** Continuous output: 2 to 16 ohms
Music signal output: 1 to 16 ohms
- **Damping Factor:** 400
- **Input Sensitivity** 1.78 V for rated continuous average output
0.11 V for 1 watt output
- **Input Impedance** Balanced: 40 kilohms
Unbalanced: 20 kilohms
- **Signal-to-Noise Ratio** (A-weighted) 125 dB with input shorted,
at rated continuous average output
- **Analog Output Level Meter** Logarithmic compression scale
Output indication in dB and %
- **Power requirements** AC 120 V / 230 V, 50 / 60 Hz
(Voltage as indicated on rear panel)
- **Power Consumption** 170 watts idle
853 watts in accordance with IEC-65
- **Maximum dimensions** 465 mm (18-5/16") width
258 mm (10-3/16") height
545 mm (21-7/16") depth
- **Weight** 49 kg (108.0 lbs.) net
58 kg (127.8 lbs.) in shipping carton



ACCUPHASE LABORATORY INC.

H0205Y PRINTED IN JAPAN 851-0128-00 (AD1)

• Specifications and design subject to change without notice for improvements.